

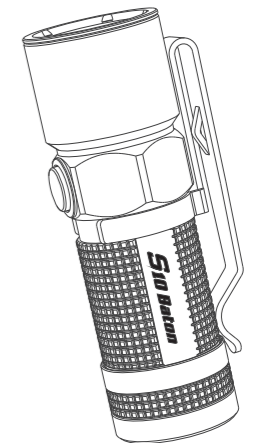

S10 BATON
VARIABLE-OUTPUT SIDE-SWITCH LED FLASHLIGHT

USER MANUAL



Thank you for purchasing the Olight S10 Baton flashlight! Please read this manual carefully before using this product.

INSIDE THE BOX

S10 Baton, (2) O-rings, (1) Silicone pad, Lanyard, user manual

WARRANTY

Within 30 days of purchase: Return to retailer from which you purchased for repair or replacement.

Within 5 years of purchase: Return to Olight for repair or replacement.

This warranty does not cover normal wear and tear, modifications, misuse, disintegrations, negligence, accidents, improper maintenance, or repair by anyone other than an Authorized retailer or Olight itself.



Technical Support Inquiries

techsupport@olightworld.com

Customer Service

service@olightworld.com

Visit www.olightworld.com to see our complete product line of portable illumination tools.



Olight Technology Co., Limited
2/F East, Building A, B3 Block, Fuhai Industrial Park, Fuyong, Bao'an District, Shenzhen, China 518103

V1. MARCH 24, 2014

HOW TO OPERATE

ON/OFF: Click the side switch to turn flashlight on.

CHANGE BRIGHTNESS LEVEL (FIG A)

Press and hold the side switch when the light is on. The brightness levels will cycle up then repeats low – medium – high until level is selected. Release the switch when on the desired brightness level to select it.

MOONLIGHT: Press and hold the side switch when the light is off.

STROBE: Double click the side switch when the light is on.

LOCK OUT: (FIG B) Press and hold the side switch for approximately two seconds when the light is off. The light will quickly flash the moonlight mode then turn off. The lock out mode will prevent the side switch and tail cap from turning on to prevent accidental activation.

UNLOCK: (FIG B) Press and hold the side switch for approximately one second when the light is locked. The light will automatically be in moonlight mode.

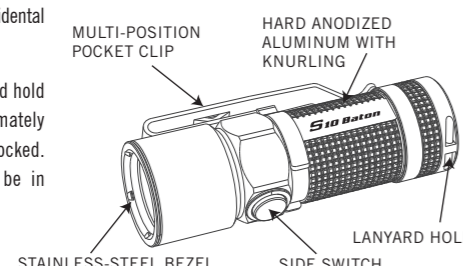
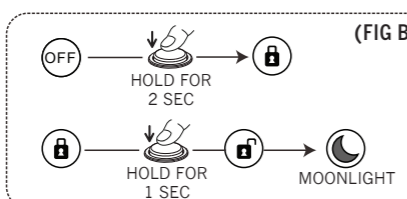
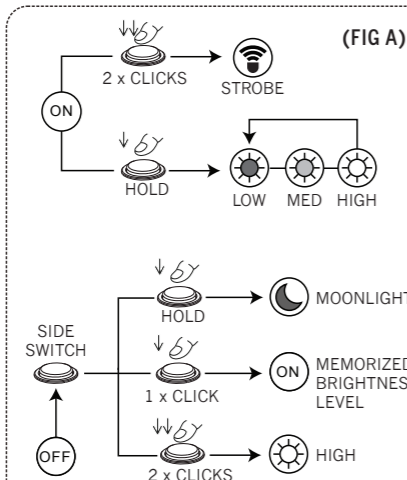

BATTERY INSTALLATION

Ensure batteries are inserted with the positive (+) end pointing to the head. The S10 Baton will not operate with incorrectly inserted batteries.

SUPPORTED BATTERIES

- 1 x CR123A
- 1 x RCR123A

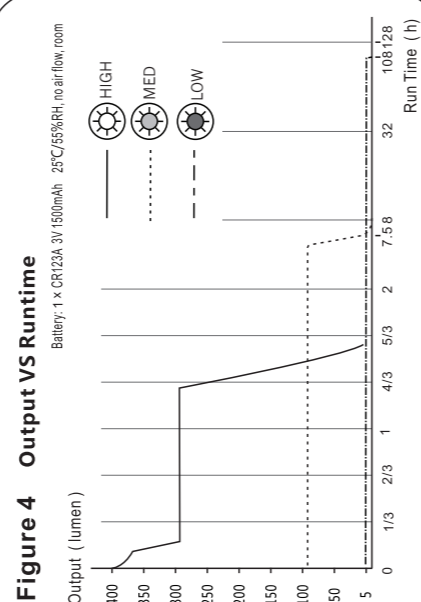
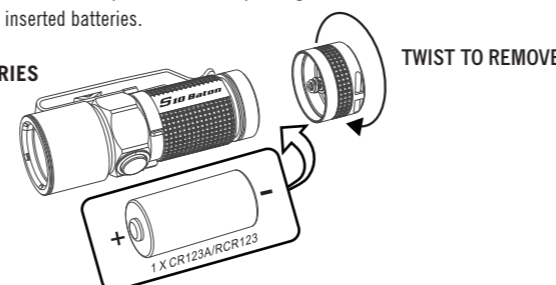

SPECIFICATIONS

OUTPUT & RUNTIME	
HIGH	400 LUMENS / 1.25 HRS
MED	85 LUMENS / 7.5 HRS
LOW	5 LUMENS / 108 HRS
MOONLIGHT	0.5 LUMEN / 360 HRS
STROBE	400 LUMENS (10HZ) / 2.5 HRS
LED	CREE XM-L2
VOLTAGE	2.5V TO 4.2V
CANDELLA	2,700 CD
BEAM DISTANCE	104 METERS / 341 FEET
BATTERY TYPE	1 x CR123A
BODY TYPE	TYPE-III HARD ANODIZED ALUMINUM
WATERPROOF	IPX8 (UP TO 2 METERS)
IMPACT RESISTANCE	2 METERS
DIMENSIONS	L 70.5mm x D 23mm / 2.78 in x 0.91in
WEIGHT	42g / 1.48 oz

Note: Testing with 1 piece of 3.0V 1,500mAh CR123A

REMOVING THE MAGNET TOOL NEEDED: TWEEZERS

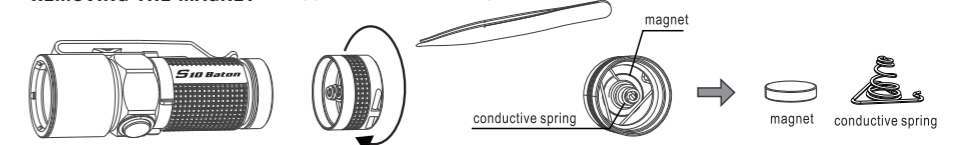

1 Put the tips of the tweezer into the location as show on the right, then pinch the tweezers so that the roots of the conductive spring release from the groves in the tailcap, and pull the spring out gently. Once the conductive spring is removed the magnet should fall out.

2 There is a small silicone pad (11.8mm, 2.5mm thick that came with your light in a small accessory pouch. Place this silicone pad into the location where the magnet was.

3 With tweezers reinsert the conductive spring back into the tailcap. In sequence insert foot A, then foot B, then foot C into the groove of the tailcap.

